

HORQUILLA MÓVIL ECA 80

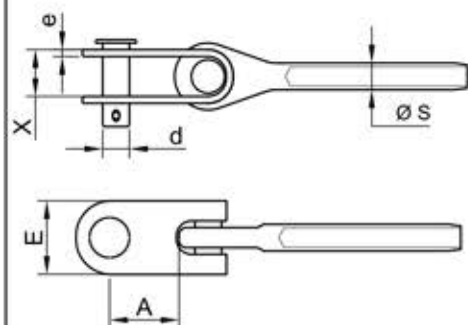

A	28
E	32
X	13
e	3,5
d	12
ØS	13

TENSOR HORQUILLA MÓVIL RCS 80

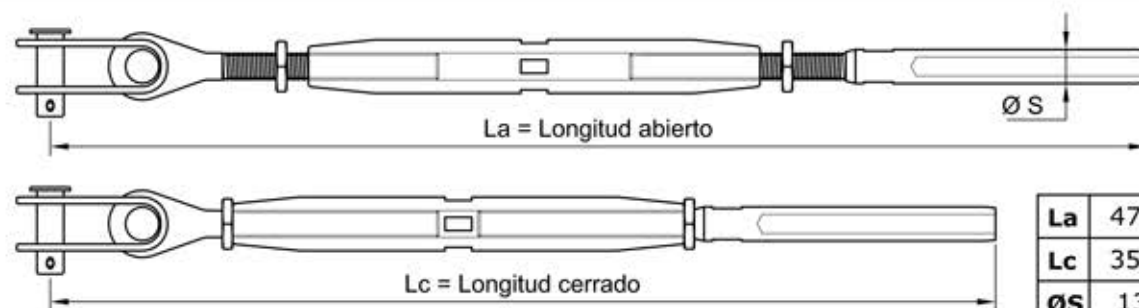

La	470
Lc	355
ØS	13

CABLE INOXIDABLE 316



7 x 19



Cable Ø	8
Carga rotura (Kg)	3.410
Composición	7x19
Calidad	AISI 316
Límite elástico	60 %

DIMENSIONADO DEL PUNTO DE ANCLAJE

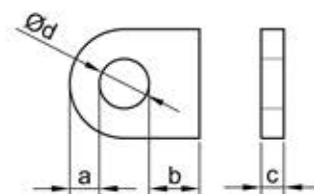

	Min	Max
a	13	19
b	17	X
c	7	12
d	13	X

IGENA, S.A.

Tel : 93 753 17 11
Fax : 93 753 31 59

HORQUILLA MÓVIL
TENSOR DE HORQUILLA MÓVIL

ECA 80 - RCS 80



Cotas en mm

Plano D04