

HORQUILLA MÓVIL ECA 140

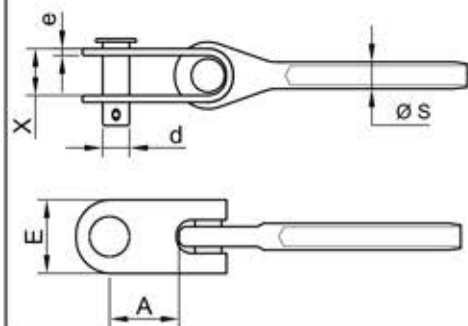

A	44
E	60
X	22
e	6
d	20
ØS	24

TENSOR HORQUILLA MÓVIL RCS 140

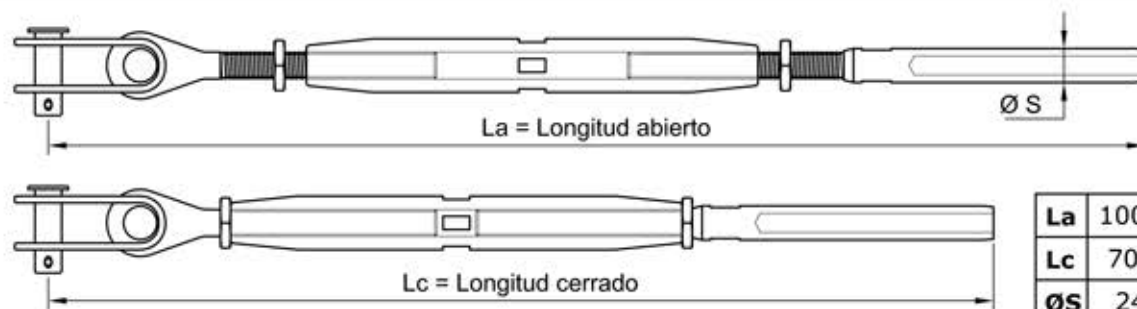

La	1000
Lc	700
ØS	24

CABLE INOXIDABLE 316



1 x 19



Cable Ø	14
Carga rotura (Kg)	13.720
Composición	1x19
Calidad	AISI 316
Límite elástico	70 %

DIMENSIONADO DEL PUNTO DE ANCLAJE

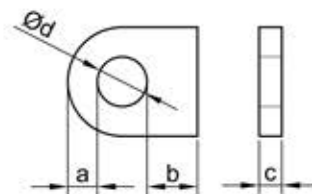

	Min	Max
a	21	30
b	28	X
c	12	20
d	21	X

IGENA, S.A.

Tel : 93 753 17 11
Fax : 93 753 31 59

HORQUILLA MÓVIL
TENSOR DE HORQUILLA MÓVIL

ECA 140 - RCS 140



Cotas en mm

Plano A08