

HORQUILLA MÓVIL ECA 50

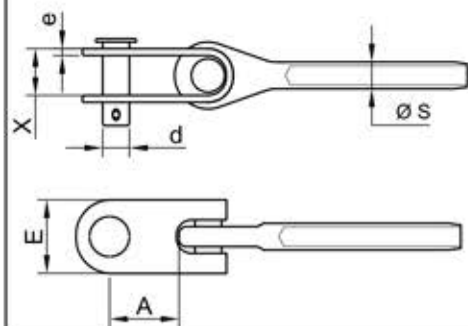

A	19
E	20
X	9
e	2,5
d	8
ØS	9

TENSOR HORQUILLA MÓVIL RCS 50

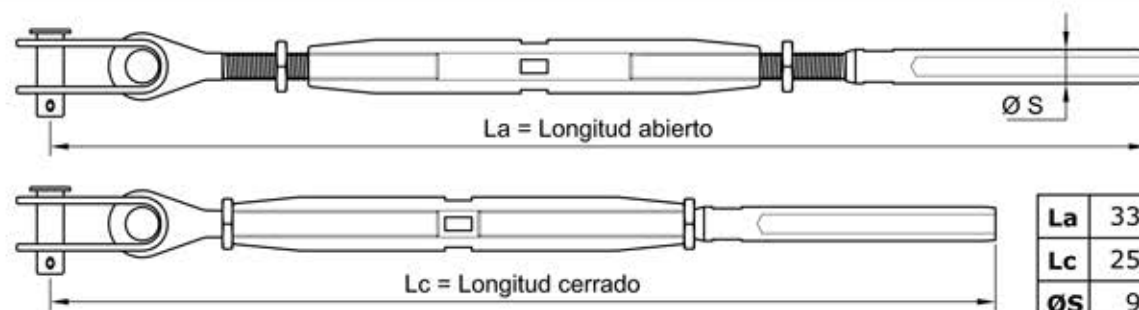

La	335
Lc	255
ØS	9

CABLE INOXIDABLE 316



1 x 19



Cable Ø	5
Carga rotura (Kg)	2.160
Composición	1x19
Calidad	AISI 316
Límite elástico	70 %

DIMENSIONADO DEL PUNTO DE ANCLAJE

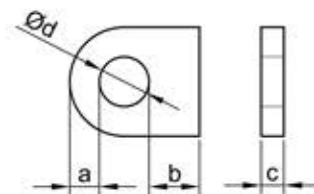

	Min	Max
a	9	13
b	12	X
c	5	8
d	9	X

IGENA, S.A.

Tel : 93 753 17 11
Fax : 93 753 31 59

HORQUILLA MÓVIL
TENSOR DE HORQUILLA MÓVIL

ECA 50 - RCS 50



Cotas en mm

Plano A02